

Scan to get more



support@conow.com
(DE) +49 (800) 001 0250



Network Diagram

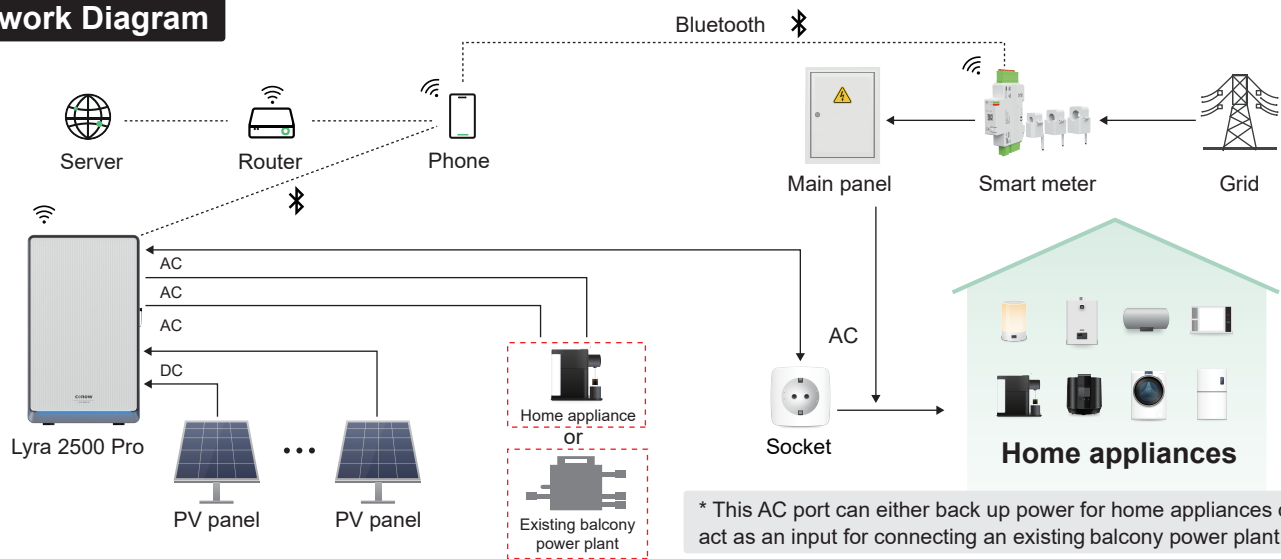

* This AC port can either back up power for home appliances or act as an input for connecting an existing balcony power plant.

1. Introduction

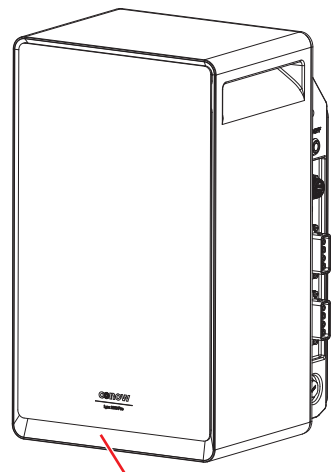

Indicator light

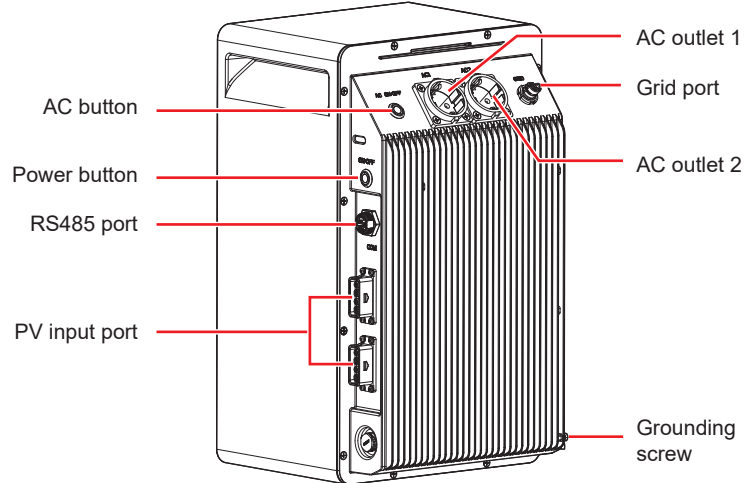

2. Packing List

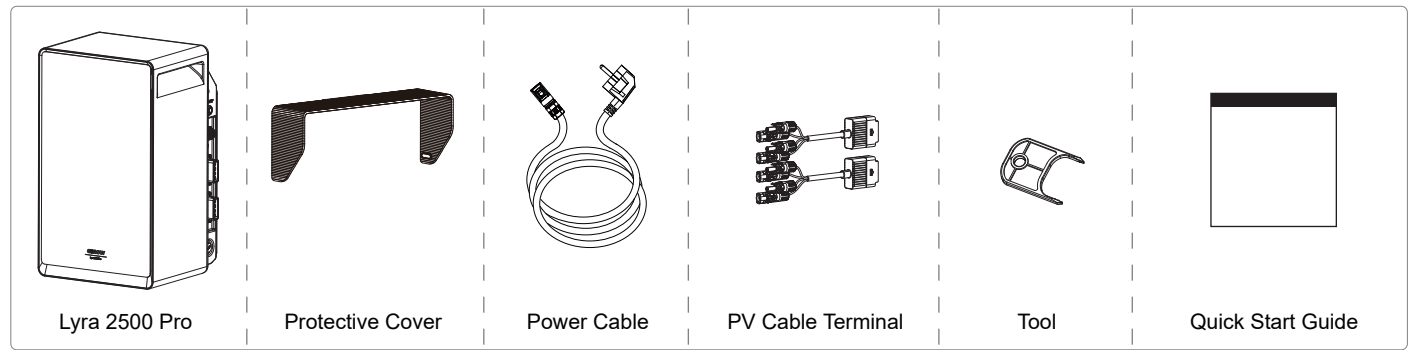

3. Installation

Install the protective cover and PV cables terminal.

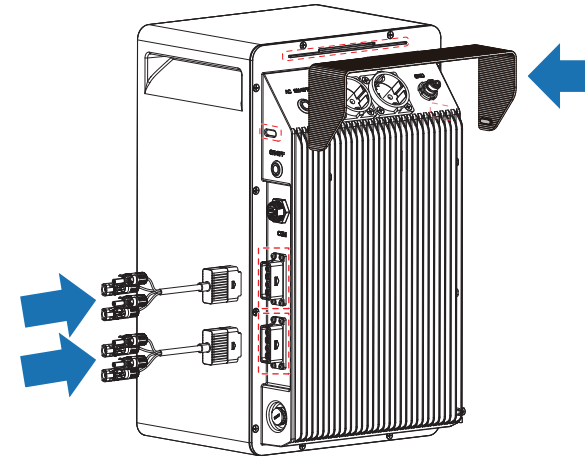

Place the Lyra 2500 Pro in a suitable location.

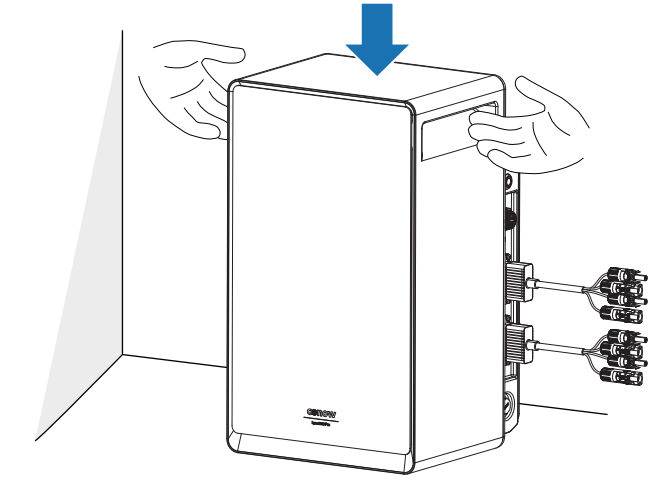

* To protect yourself and the equipment, ensure the system is powered off before installing or adding an additional Lyra 2500 Pro. Installation while the system is powered on is not covered under warranty.

- Ensure that unused PV input ports are sealed with waterproof caps.
- Do not connect the same set of photovoltaic (PV) connectors to different PV input ports. For example, do not connect the positive connector of PV1 to the input port of PV2.

Never connect two or more panels in series, because this causes the input voltage to exceed 60V and will damage the equipment.

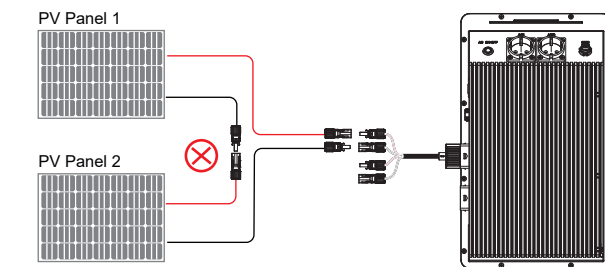
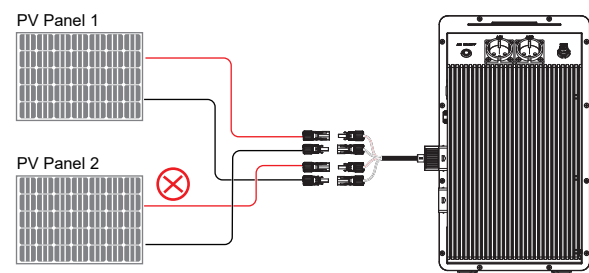

Direct Connection (Up to 4 PV Panels)

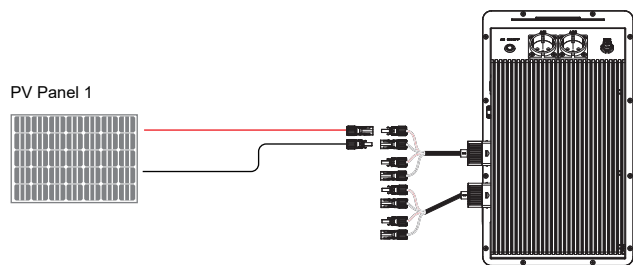

Parallel Connection (Up to 8 PV Panels)

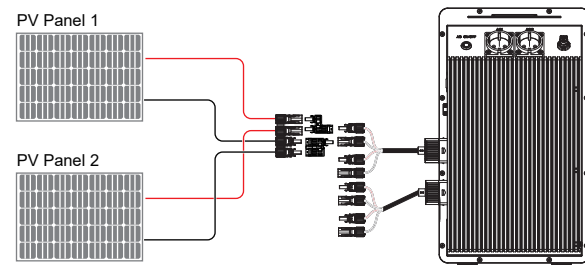

Two devices are used together

* When two devices are used together, the total maximum output power is 2400W. The system will automatically adjust the output power of the device based on the power of the connected loads.

Note: The total power consumption of all AC output ports on both devices must not exceed 2400W.

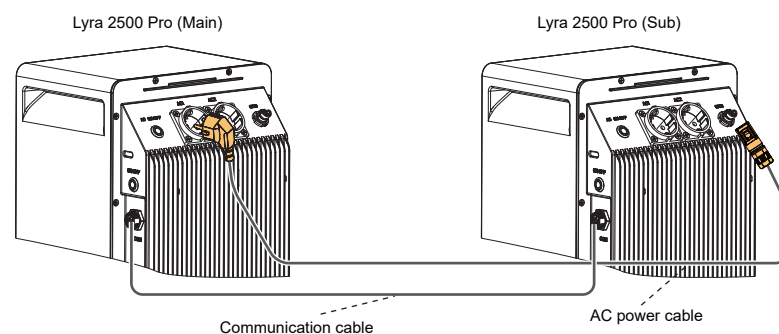

Wiring Diagram

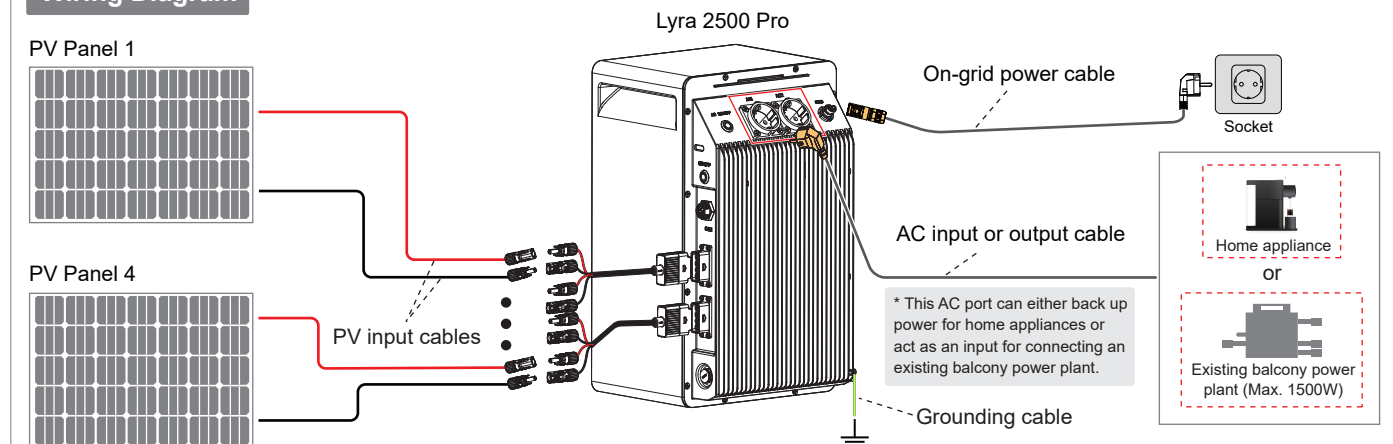

4. Commissioning Procedure

Downloading the App

- Scan the QR code or search for "CONOW ECO" in the Google Play Store or Apple App Store. After downloading, please register and log in to the App.
- Scan the QR code on the device to download the App.

* If you have already downloaded the "SmartLife" or "Tuya" App, you may use your existing App directly, as its operation is identical to that of CONOW ECO.



Obtain the User Guide

Device Network Configuration

1. Press the power button to turn on the device (the LED indicator will turn on, and the power button indicator will flash).
2. Press the AC switch button for 1 second to enable the bypass function (the button indicator light is on).
3. Check the LED indicator to confirm the device is in pairing mode (the power button indicator light is flashing).
4. Scan the QR code to view the electronic manual and follow the instructions on adding devices and configuring settings.
5. After adding the device, you can access the electronic manual on the device page.

